



R-CONTROL SIPs

STRUCTURAL INSULATED PANELS



Note: Information deemed reliable at time of printing.
Please visit www.r-control.com for latest information. June 2020

**CONTROL,
NOT COMPROMISE.®**

www.r-control.com



LOAD DESIGN CHARTS

When you choose R-Control SIPs, you're collaborating with a team of experts who work with you every step of the way. We're here to answer your questions, solve your problems, and do everything we can to make sure your project proceeds smoothly—and ends successfully.

R-Control SIPs are manufactured by a network of licensed manufacturers throughout North America and the world. R-Control SIP licensed facilities adhere to strict, consistent standards to ensure high-quality custom-made R-Control SIPs.

This network allows us to offer architects, engineers and builders the best of both worlds: the resources of the country's largest provider of SIP products and systems, and the superior attention and customer service of a local supplier.

R-Control SIPs are structural components for use in load bearing wall, roof, ceiling, or floor assemblies. An R-Control SIP Construction Manual, technical bulletins, and a building techniques video are available with additional information. These documents should be reviewed in detail prior to design and installation of R-Control SIPs. You can download these documents from www.r-control.com.

Table of Contents:

Page

3 Architect/Engineering Review
 3 Construction Manual and Video
 3 R-Control SIP Weight
 3 R-Control SIP R-value
 4 Wall - Uniform Axial Loads
 5 Wall - Point Axial Loads
 6 Wall - Transverse Loads
 7 Wall - Shear Loads
 8 Wall - Header Loads
 9 Roof/Floor Transverse Loads - Surface / Block / Lumber Block Spline
 10 Roof/Floor Transverse Loads - Double 2X Spline
 11 Roof/Floor Transverse Loads - I-Beam Spline
 12 Roof/Floor Transverse Loads - LVL Spline
 13 Roof - Uplift Loads
 14 Roof/Floor Diaphragm Loads

Architect/Engineering Review

The Load Design Charts for R-Control SIPs have been developed from national testing standards, testing at independent laboratories, and qualified structural engineers. These charts cover most common construction requirements. Each building project should be reviewed by an architect/engineer to determine the suitability of R-Control SIPs.

Evaluation Reports

The International Code Council Evaluation Service (ICC-ES) has reviewed the independent testing, structural engineering, PFS Corporation third party inspections, and QC program for R-Control SIPs and has issued evaluation report ESR-2233. NTA Inc has also issued assembly report AFM031809-18.



Building Codes

R-Control SIPs are recognized as being in compliance with the 2006, 2009, and 2012 International Building Code and 2006, 2009, and 2012 International Residential Code. R-Control SIPs should be designed to comply with the deflection limits of the applicable building code.

R-Control SIP Weight

SIP THICKNESS	WEIGHT (psf)
4-1/2"	3.2
6-1/2"	3.4
8-1/4"	3.6
10-1/4"	3.8
12-1/4"	4.0

R-Control SIP R-value

SIP THICKNESS	R-VALUE @ 75°F	R-VALUE @ 40°F
4-1/2"	14.9	16.0
6-1/2"	22.6	24.4
8-1/4"	29.3	31.7
10-1/4"	37.0	40.0
12-1/4"	44.7	48.3



Wall - Uniform Axial Loads - PLF						
LOAD DESIGN CHART #2B						
DETAIL SIP-101c						
SIP THICKNESS	SIP HEIGHT (feet)					
	8	8 WAB ¹	10	12	14	16
4-1/2"	2750	2300	2500	2000		
6-1/2"	4000	2400	3500	3000	2750	2500
8-1/4"	4000	2400	3500	3000	2750	2500
10-1/4"	4000	2400	3500	3000	2750	2500
12-1/4"	4000	2400	3500	3000	2750	2500

¹ WAB = SIPS INSTALLED WITH THE STRONG AXIS OF THE OSB FACINGS PERPENDICULAR TO SIP HEIGHT.

GENERAL NOTES:

- CHART VALUES ARE POUNDS PER LINEAL FOOT.
- LOADS LIMITED BY DEFLECTION OR ULTIMATE FAILURE LOAD DIVIDED BY A FACTOR OF SAFETY OF THREE.
- WALL AXIAL LOADS SHALL BE DESIGNED TO THE LESSER OF THE UNIFORM AXIAL LOADS OF LOAD DESIGN CHART #2B OR THE POINT AXIAL LOADS OF LOAD DESIGN CHART #2C.

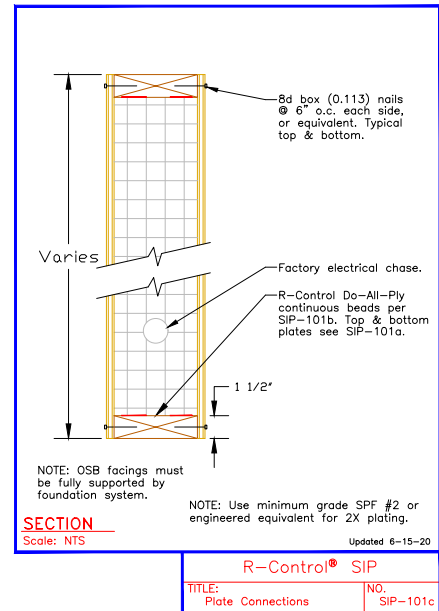

Wall-Unity Equation

This wall-unity equation is used to determine design suitability. The equation takes into account the ultimate load for a SIP subjected to both axial and transverse conditions:

$$\frac{\text{design axial load}}{\text{allowable axial load}} + \frac{\text{design transverse load}}{\text{allowable transverse load}} \leq 1$$

(SEE LOAD DESIGN CHART #2B) (SEE LOAD DESIGN CHART #4)

Wall - Point Axial Loads - LBS LOAD DESIGN CHART #2C DETAILS SIP-101c, SIP-101d, or SIP-101e			
POINT LOAD WIDTH	SINGLE TOP PLATE	W/SPACER PLATE ¹	W/CAP PLATE ²
1-1/2"	2000	2100	4000
3"	2150	3000	4150

¹ MINIMUM 3/8" CDX PLYWOOD OR EQUIVALENT
² MINIMUM SPF#2 2X OR EQUIVALENT

GENERAL NOTES:

- CHART VALUES ARE POUNDS.
- LOADS LIMITED BY DEFLECTION OR ULTIMATE FAILURE LOAD DIVIDED BY A FACTOR OF SAFETY OF THREE.
- WALL AXIAL LOADS SHALL BE DESIGNED TO THE LESSER OF THE POINT AXIAL LOADS OF LOAD DESIGN CHART #2C OR THE UNIFORM AXIAL LOADS OF LOAD DESIGN CHART #2B.
- FOR POINT LOADS EXCEEDING THESE CAPACITIES, USE POSTS TO TRANSFER LOADS AS REQUIRED.

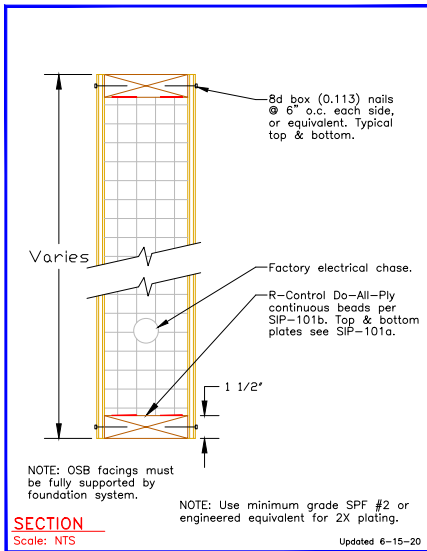

R-Control® SIP
 TITLE: Plate Connections NO. SIP-101c

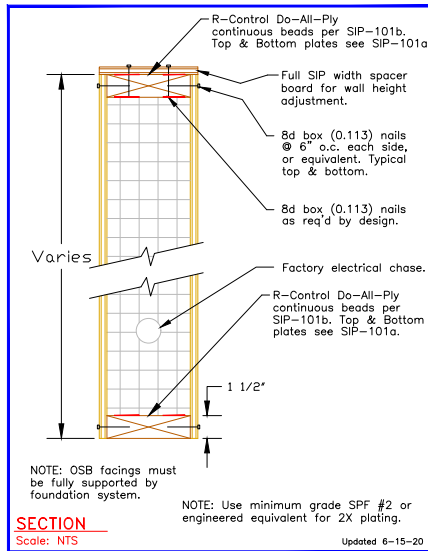

R-Control® SIP
 TITLE: Plate Connection with Spacer Board NO. SIP-101d

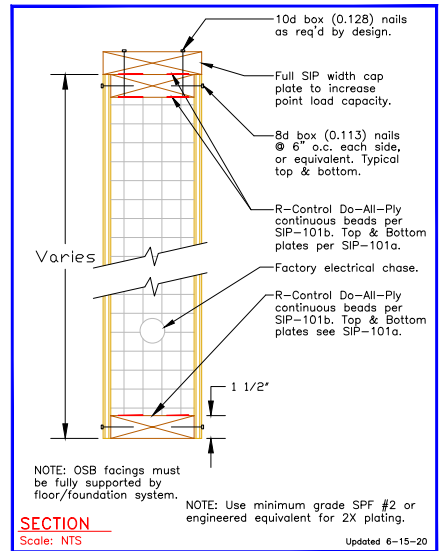

R-Control® SIP
 TITLE: Plate Connection with Cap Plate NO. SIP-101e



Wall - Transverse Loads - PSF LOAD DESIGN CHART #4 DETAIL SIP-101c							
SIP THICKNESS	DEFLECTION LIMIT	SIP HEIGHT (feet)					
		8	8WAB ¹	10	12	14	16
4-1/2"	L/360	30	30	22	17		
	L/240	46	40	33	25		
	L/180	56	40	45	34		
6-1/2"	L/360	48	40	36	28	22	18
	L/240	56	40	45	38	32	27
	L/180	56	40	45	38	32	28
8-1/4"	L/360	56	40	45	38	31	25
	L/240	56	40	45	38	32	28
	L/180	56	40	45	38	32	28
10-1/4"	L/360	56	40	45	38	32	28
	L/240	56	40	45	38	32	28
	L/180	56	40	45	38	32	28
12-1/4"	L/360	56	40	45	38	32	28
	L/240	56	40	45	38	32	28
	L/180	56	40	45	38	32	28

¹ WAB = SIPS INSTALLED WITH THE STRONG AXIS OF THE OSB FACINGS PERPENDICULAR TO SIP HEIGHT.

GENERAL NOTES:

- CHART VALUES ARE POUNDS PER SQUARE FOOT.
- CHART VALUES ARE APPLICABLE TO ANY SPLINE CONNECTION.
- SURFACE, BLOCK, OR LUMBER BLOCK SPLINE CONNECTED TO SIP FACING WITH 8d BOX (0.113) @ 6" O.C.
- SIP FACING CONNECTED TO TOP AND BOTTOM PLATE WITH 8d BOX (0.113) @ 6" O.C.
- VALUES ARE FOR TOTAL LOAD (DEAD LOAD + LIVE LOAD).
- LOADS LIMITED BY DEFLECTION OR ULTIMATE FAILURE LOAD DIVIDED BY A FACTOR OF SAFETY OF THREE.

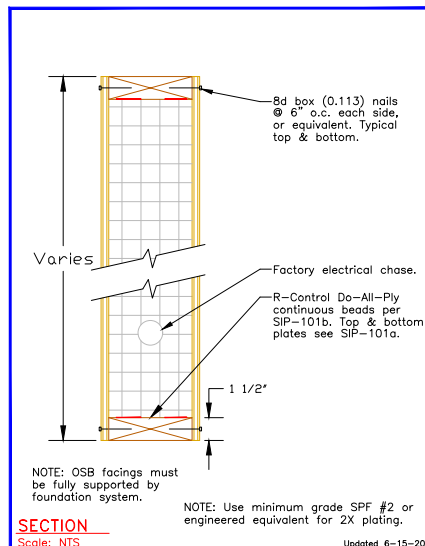

R-Control® SIP	
TITLE: Plate Connections	NO. SIP-101c

Wall - Shear Loads - PLF LOAD DESIGN CHART #6 SPLINE DETAILS SIP-102, SIP-102g, SIP-102m, or SIP-102k			
SPLINE TYPE	CONNECTIONS		SHEAR STRENGTH (PLF)
	NAIL TYPE	NAIL SPACING	
Surface or Block	8d Box (2-1/2" x 0.113")	6" o.c.	335
1X Lumber Block	8d Cooler (2-3/8" x 0.113")	Two staggered rows 4" o.c.	540
4X Lumber	8d Cooler (2-3/8" x 0.113")	Two staggered rows 4" o.c.	540
4X Lumber	8d Cooler (2-3/8" x 0.113")	Two staggered rows 3" o.c.	720
4X Lumber	8d Cooler (2-3/8" x 0.113")	Two staggered rows 2" o.c.	920

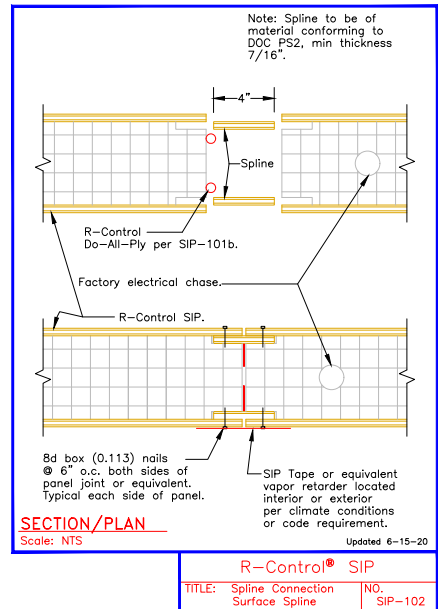

GENERAL NOTES:

- CHART VALUES ARE POUNDS PER LINEAL FEET.
- CHART VALUES ARE APPLICABLE TO ANY THICKNESS SIP.
- LOADS LIMITED BY DEFLECTION OR ULTIMATE FAILURE LOAD DIVIDED BY A FACTOR OF SAFETY OF THREE.
- REQUIRED CONNECTIONS MUST BE MADE ON BOTH SIDES OF SPLINE JOINT, BOTTOM PLATE, TOP PLATE, AND EACH SIDE OF THE SIP.
- TOP PLATE JOINTS MUST BE STAGGERED A MINIMUM OF ONE FOOT FROM SPLINE JOINTS.
- PLATES, CHORDS, HOLDOWNS, AND CONNECTIONS TO OTHER STRUCTURAL ELEMENTS MUST BE DESIGNED BY A REGISTERED DESIGN PROFESSIONAL IN ACCORDANCE WITH ACCEPTED ENGINEERING PRACTICE.

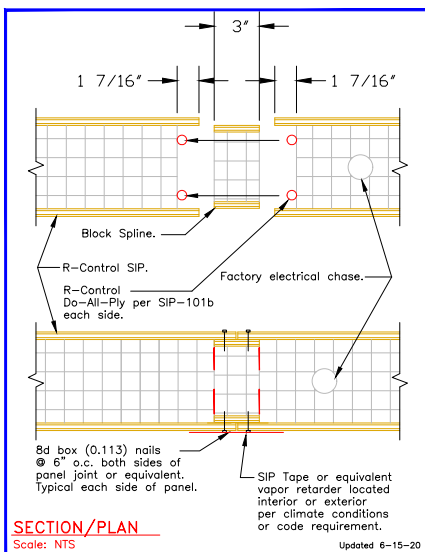

R-Control® SIP
 TITLE: Spline Connection Block Spline NO. SIP-102g

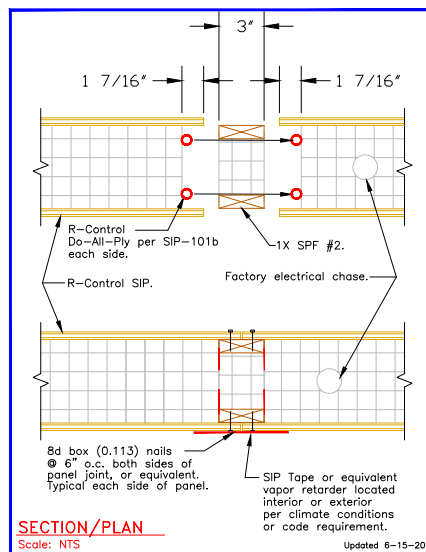

R-Control® SIP
 TITLE: Spline Connection 1X Lumber Block NO. SIP-102m

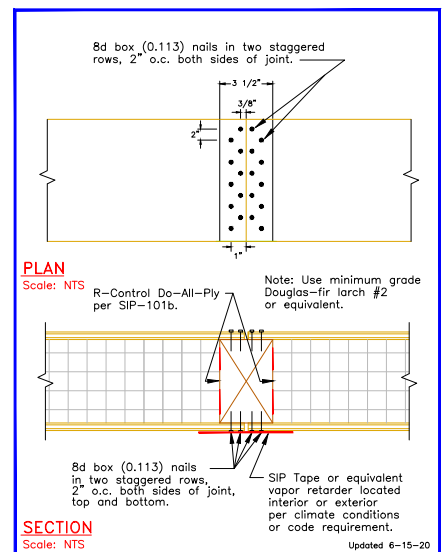

R-Control® SIP
 TITLE: Spline Connection 4X - 2" o.c. NO. SIP-102k



Wall - Header Loads - PLF LOAD DESIGN CHART #5 DETAILS SIP-112 through SIP-114				
HEADER DEPTH	DEFLECTION LIMIT	HEADER SPAN (feet)		
		4	6	8
12"	L/480	524	319	218
	L/360	703	374	248
	L/240	708	374	248
18"	L/480	762	466	351
	L/360	773	466	351
	L/240	773	466	351
24"	L/480	837	557	455
	L/360	837	557	455
	L/240	837	557	455

- GENERAL NOTES:**
- CHART VALUES ARE POUNDS PER LINEAL FOOT.
 - LOADS LIMITED BY DEFLECTION OR ULTIMATE FAILURE LOAD DIVIDED BY A FACTOR OF SAFETY OF THREE.
 - POSTS SUPPORTING HEADER, WHEN REQUIRED, MUST BE DESIGNED BY A REGISTERED DESIGN PROFESSIONAL IN ACCORDANCE WITH ACCEPTED ENGINEERING PRACTICE.

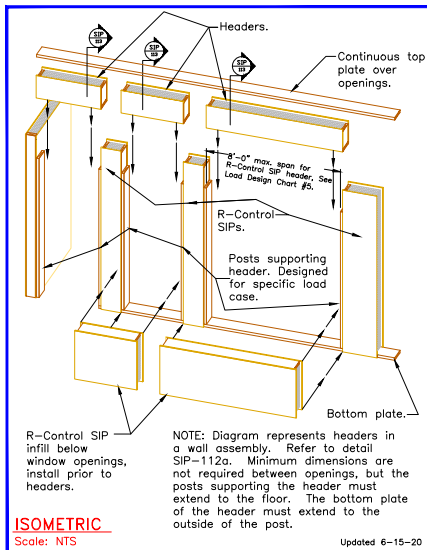

R-Control® SIP
TITLE: Headers NO. SIP-112

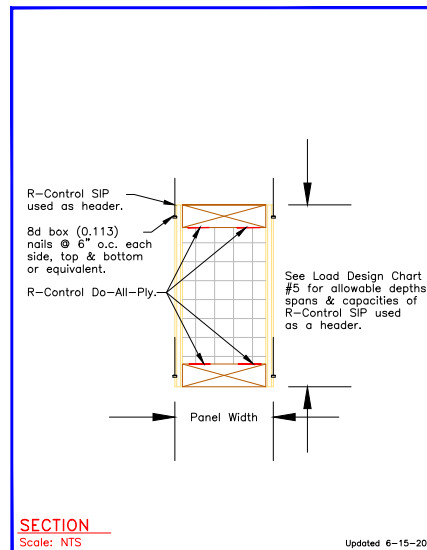

R-Control® SIP
TITLE: SIP Header Plates NO. SIP-113

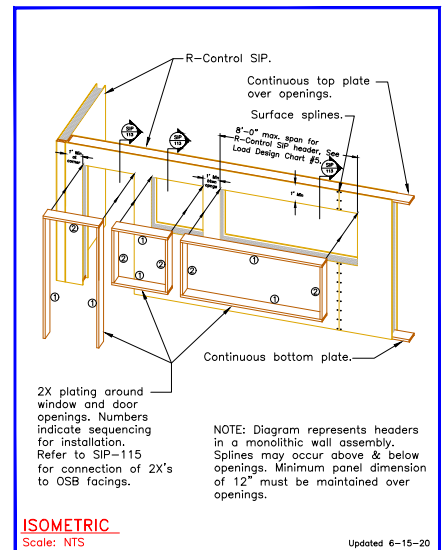

R-Control® SIP
TITLE: SIP Header NO. SIP-114

Refer to R-Control SIP Construction Manual for additional header details.

Roof/Floor - Transverse Loads - PSF						
LOAD DESIGN CHART #1						
SPLINE DETAILS SIP-102, SIP-102g, or SIP-102m						
SIP THICKNESS	DEFLECTION LIMIT	SIP SPAN (feet)				
		4	6	8 ¹	10	12
4-1/2"	L/360	69	44	30	22	
	L/240	104	65	46	33	
	L/180	127	85	61	45	
6-1/2"	L/360	105	67	48	36	
	L/240	131	88	66	53	
	L/180	131	88	66	53	
8-1/4"	L/360	135	88	63	48	38
	L/240	135	90	68	54	45
	L/180	135	90	68	54	45
10-1/4"	L/360	140	92	69	55	46
	L/240	140	92	69	55	46
	L/180	140	92	69	55	46
12-1/4"	L/360	138	92	69	55	46
	L/240	138	92	69	55	46
	L/180	138	92	69	55	46

¹ VALUES FOR 8FT SPAN ARE APPLICABLE TO SIPS INSTALLED WITH THE STRONG AXIS OF THE OSB FACINGS PARALLEL OR PERPENDICULAR TO SIP SPAN.

GENERAL NOTES:

- CHART VALUES ARE POUNDS PER SQUARE FOOT.
- SURFACE, BLOCK, OR LUMBER BLOCK SPLINE CONNECTED TO SIP FACING WITH 8d BOX (0.113) NAILS 6" O.C.
- CONTINUOUS SUPPORT WITH A MINIMUM BEARING OF 1-1/2" AT EACH END REQUIRED.
- CHART IS BASED UPON UNIFORM LOADS.
- LOADS LIMITED BY DEFLECTION OR ULTIMATE FAILURE LOAD DIVIDED BY A FACTOR OF SAFETY OF THREE.
- FLOORS MUST HAVE A MINIMUM 7/16" THICK OSB OR EQUIVALENT OVERLAY.
- FOR SLOPED SIPS, THE LOADING CONDITIONS AND SIP CAPACITIES SHOULD BE REVIEWED BASED UPON THE INCLINED SIP LENGTH. REFER TO R-CONTROL SIP TECHNICAL BULLETIN SIP NO. 2042.
- VALUES ARE FOR TOTAL LOAD (DEAD LOAD + LIVE LOAD).
- DEFLECTION BASED UPON $K_{CR}=1.0$. FOR LONG TERM DEFLECTION UNDER SUSTAINED LOAD (CREEP), ADDITIONAL DEFLECTION MUST BE EVALUATED.

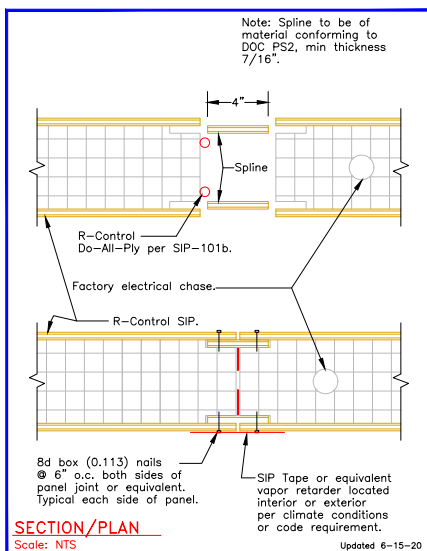

R-Control® SIP
 TITLE: Spline Connection Surface Spline NO. SIP-102

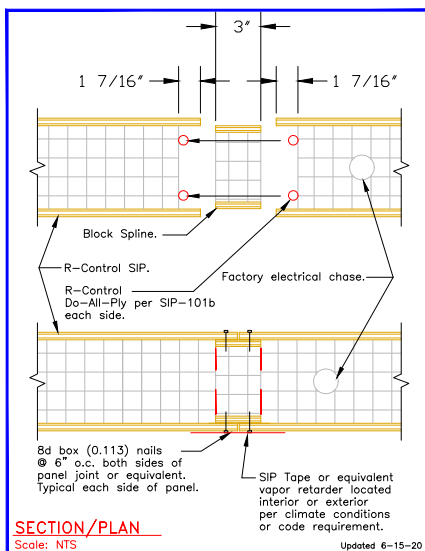

R-Control® SIP
 TITLE: Spline Connection Block Spline NO. SIP-102g

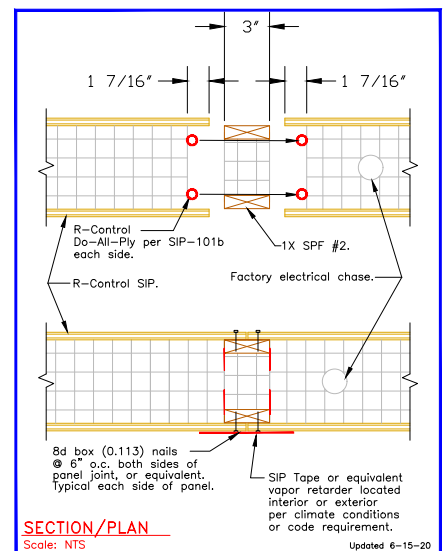

R-Control® SIP
 TITLE: Spline Connection 1X Lumber Block NO. SIP-102m



Roof/Floor - Transverse Loads - PSF									
LOAD DESIGN CHART #3									
DOUBLE 2X SPLINE DETAILS SIP-102d and SIP-108									
SIP THICKNESS	DEFLECTION LIMIT	SIP SPAN (feet)							
		10	12	14	16	18	20	22	24
6-1/2"	L/360	53	40	30	24	19	15		
	L/240	79	59	45	35	28	22		
	L/180	105	79	60	47	37	30		
8-1/4"	L/360	89	65	48	37	28	22		
	L/240	109	91	72	55	42	33		
	L/180	109	91	78	68	57	44		
10-1/4"	L/360	150	111	84	65	51	41	33	27
	L/240	174	145	124	98	77	61	49	40
	L/180	174	145	124	109	97	82	66	54
12-1/4"	L/360	177	148	115	89	70	56	45	37
	L/240	177	148	127	111	99	84	68	55
	L/180	177	148	127	111	99	89	81	74

GENERAL NOTES:

- CHART VALUES ARE POUNDS PER SQUARE FOOT.
- DOUBLE 2X SPLINE MUST BE CONTINUOUS, SPACED 4' O.C., AND CONNECTED TO SIP FACING WITH 8d BOX (0.113) NAILS 6" O.C.
- CONTINUOUS SUPPORT WITH A MINIMUM DOUBLE 2X SPLINE BEARING OF 1-1/2" AT EACH END REQUIRED.
- CHART IS BASED UPON UNIFORM LOADS.
- LOADS LIMITED BY DEFLECTION OR ULTIMATE FAILURE LOAD DIVIDED BY A FACTOR OF SAFETY OF THREE.
- FLOORS MUST HAVE A MINIMUM 7/16" THICK OSB OR EQUIVALENT OVERLAY.
- FOR SPANS GREATER THAN 22' AND FOR ALL 12-1/4" SIPs, DOUBLE 2X SPLINE IS REQUIRED TO BE #2 DOUGLAS FIR OR BETTER.
- FOR SLOPED SIPs, THE LOADING CONDITIONS AND SIP CAPACITIES SHOULD BE REVIEWED BASED UPON THE INCLINED SIP LENGTH. REFER TO R-CONTROL SIP TECHNICAL BULLETIN SIP NO. 2042.
- VALUES ARE FOR TOTAL LOAD (DEAD LOAD + LIVE LOAD).
- DEFLECTION BASED UPON $K_{CR} = 1.0$. FOR LONG TERM DEFLECTION UNDER SUSTAINED LOAD (CREEP), ADDITIONAL DEFLECTION MUST BE EVALUATED.

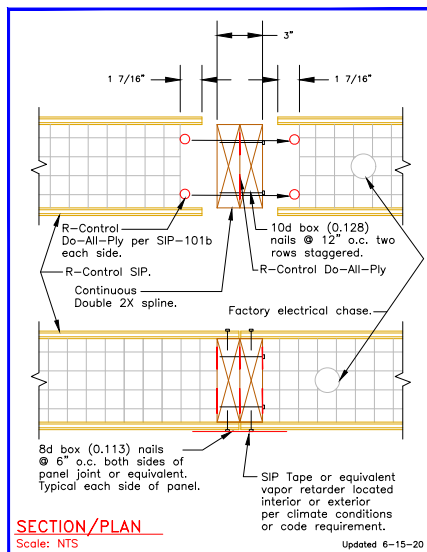

SECTION/PLAN
Scale: NTS

R-CONTROL® SIP
 TITLE: Spline Connection Double 2X NO. SIP-102d

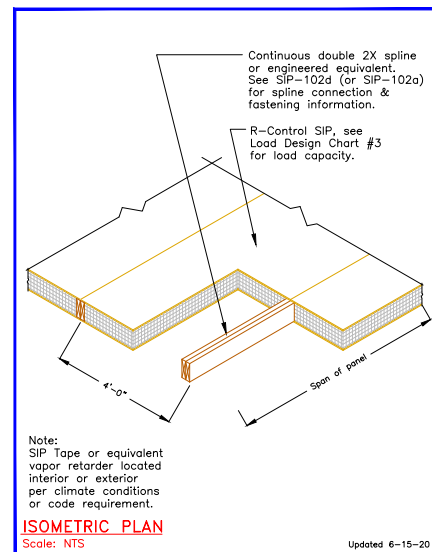

ISOMETRIC PLAN
Scale: NTS

R-CONTROL® SIP
 TITLE: Floor/Roof SIP 2X Connection NO. SIP-108

Roof/Floor - Transverse Loads - PSF LOAD DESIGN CHART #3A I-BEAM SPLINE DETAILS SIP-102b and SIP-108a									
SIP THICKNESS	DEFLECTION LIMIT	SIP SPAN (feet)							
		10	12	14	16	18	20	22	24
10-1/4"	L/360	118	98	73	55	42	33	26	21
	L/240	118	98	84	74	63	49	39	31
	L/180	118	98	84	74	65	59	49	41
12-1/4"	L/360	131	109	87	69	55	45	37	30
	L/240	131	109	93	82	72	65	55	46
	L/180	131	109	93	82	72	65	57	48

GENERAL NOTES:

- CHART VALUES ARE POUNDS PER SQUARE FOOT.
- I-BEAM SPLINE MUST BE CONTINUOUS, SPACED 4' O.C., AND CONNECTED TO SIP FACING WITH 8d BOX (0.113) NAILS 6" O.C.
- CONTINUOUS SUPPORT WITH A MINIMUM I-BEAM SPLINE BEARING OF 1-1/2" AT EACH END REQUIRED.
- CHART IS BASED UPON UNIFORM LOADS.
- LOADS LIMITED BY DEFLECTION OR ULTIMATE FAILURE LOAD DIVIDED BY A FACTOR OF SAFETY OF THREE.
- FLOORS MUST HAVE A MINIMUM 7/16" THICK OSB OR EQUIVALENT OVERLAY.
- FOR SLOPED SIPs, THE LOADING CONDITIONS AND SIP CAPACITIES SHOULD BE REVIEWED BASED UPON THE INCLINED SIP LENGTH. REFER TO R-CONTROL SIP TECHNICAL BULLETIN SIP NO. 2042.
- VALUES ARE FOR TOTAL LOAD (DEAD LOAD + LIVE LOAD).
- DEFLECTION BASED UPON $K_{CR}=1.0$. FOR LONG TERM DEFLECTION UNDER SUSTAINED LOAD (CREEP), ADDITIONAL DEFLECTION MUST BE EVALUATED.

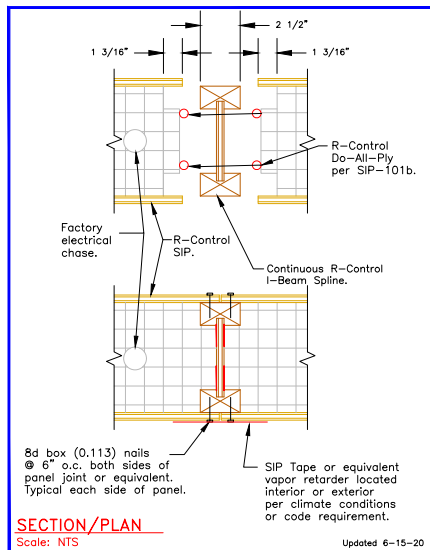

R-Control® SIP
TITLE: Spline Connection I-Beam Spline NO. SIP-102b

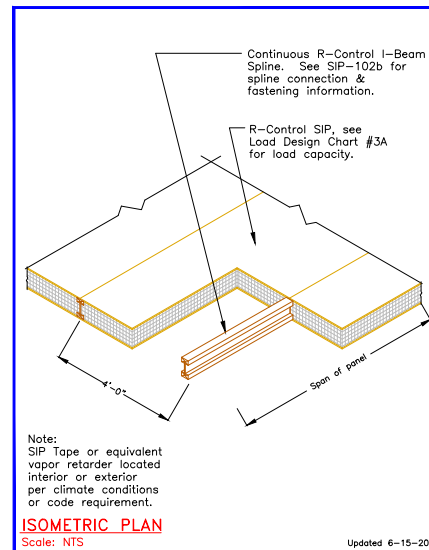

R-Control® SIP
TITLE: Floor/Roof SIP I-Beam Connection NO. SIP-108a



Roof/Floor - Transverse Loads - PSF LOAD DESIGN CHART #3C R-CONTROL LVL SPLINE DETAIL SIP-102a							
SIP THICKNESS	DEFLECTION LIMIT	SIP SPAN (feet)					
		10	12	14	16	18	20
		R-CONTROL LVL SPLINE WIDTH					
		1-3/4"			2-1/2"		
8-1/4"	L/360	81	63	49	38	30	24
	L/240	81	68	58	51	45	31
	L/180	81	68	58	51	45	40

GENERAL NOTES:

- CHART VALUES ARE POUNDS PER SQUARE FOOT.
- LVL SPLINE MUST BE CONTINUOUS, SPACED 4' O.C., AND CONNECTED TO SIP FACING WITH 8d BOX (0.113) NAILS 6" O.C.
- CONTINUOUS SUPPORT WITH A MINIMUM LVL SPLINE BEARING OF 1-1/2" AT EACH END REQUIRED.
- CHART IS BASED UPON UNIFORM LOADS.
- LOADS LIMITED BY DEFLECTION OR ULTIMATE FAILURE LOAD DIVIDED BY A FACTOR OF SAFETY OF THREE.
- FLOORS MUST HAVE A MINIMUM 7/16" THICK OSB OR EQUIVALENT OVERLAY.
- FOR SLOPED SIPs, THE LOADING CONDITIONS AND SIP CAPACITIES SHOULD BE REVIEWED BASED UPON THE INCLINED SIP LENGTH. REFER TO R-CONTROL SIP TECHNICAL BULLETIN SIP NO. 2042.
- VALUES ARE FOR TOTAL LOAD (DEAD LOAD + LIVE LOAD).
- DEFLECTION BASED UPON $K_{CR}=1.0$. FOR LONG TERM DEFLECTION UNDER SUSTAINED LOAD (CREEP), ADDITIONAL DEFLECTION MUST BE EVALUATED.

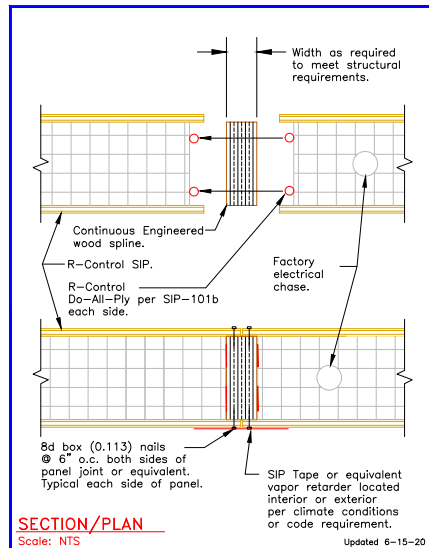

SECTION/PLAN

Scale: NTS

Updated 6-15-20

R-Control® SIP	
TITLE: Spine Connection Engineered Wood	NO. SIP-102a

Roof - Uplift Loads LOAD DESIGN CHART #8 Maximum Spacing of R-Control Wood Screws At Supports - INCHES¹			
ROOF PITCH	SIP SPAN ² (FT)	2009 IBC ³ 2009 IRC/2012 IRC WIND SPEED, V_{ASD}	2012 IBC ⁴ WIND SPEED, V_{ULT}
		90 MPH	115 MPH
1.5:12	8	12	12
	12	12	12
	16	8	8
	20	8	8
	24	6	6
3:12	8	12	12
	12	12	12
	16	8	8
	20	8	8
	24	6	6
6:12	8	12	12
	12	12	12
	16	8	8
	20	8	8
	24	6	6
9:12	8	12	12
	12	12	12
	16	8	8
	20	6	6
	24	6	6

¹ FASTENER SPACING IS BASED ON FASTENER HEAD PULL-THROUGH AND WITHDRAWAL STRENGTH OF R-CONTROL WOOD SCREWS TESTED IN ACCORDANCE WITH ASTM D1037. THE ALLOWABLE WITHDRAWAL STRENGTH AND PULL-THROUGH STRENGTH WERE TAKEN AS THE AVERAGE ULTIMATE LOAD DIVIDED BY A FACTOR OF SAFETY OF 5.0 AND A LOAD DURATION FACTOR OF 1.6 (ALLOWABLE PULL-THROUGH STRENGTH = 179 LBF, ALLOWABLE WITHDRAWAL STRENGTH = 200 LBF).

² TABLE VALUES APPLY TO SIMPLY SUPPORTED SIP ROOF MEMBERS HAVING AN OVERHANG NOT TO EXCEED 24-INCHES. WOOD SUPPORT TO HAVE A MINIMUM SPECIFIC GRAVITY, $G = 0.42$ (SPRUCE-PINE-FUR). SCREW SHALL HAVE SUFFICIENT LENGTH AND BE INSTALLED SO THAT IT PENETRATES THE WOOD SUPPORT A MINIMUM OF 1.5-INCHES.

³ THREE-SECOND-GUST WIND SPEED BASED ON A BUILDING HEIGHT OF 40-FEET, ZONE 2E, IMPORTANCE FACTOR, $L_w=1.0$ AND TOPOGRAPHIC FACTOR, $K_{zt}=1.0$, INTERNAL PRESSURE COEFFICIENT, $GC_{pi}=0.18$ IN ACCORDANCE WITH ASCE 7, 2005 EDITION, SECTION 6.5.12.2.2 (MAIN WIND FORCE RESISTING SYSTEM, LOW-RISE BUILDING). A MINIMUM ROOF ASSEMBLY DEAD LOAD OF 10 PSF IS CONSIDERED IN THE TABULATED VALUES (UPLIFT PRESSURE REDUCE BY 0.6 TIMES 10 PSF).

⁴ THREE-SECOND-GUST WIND SPEED; BASED ON A BUILDING HEIGHT OF 40-FEET, ZONE 2E, IMPORTANCE FACTOR, $L_w=1.0$ AND TOPOGRAPHIC FACTOR, $K_{zt}=1.0$, INTERNAL PRESSURE COEFFICIENT, $GC_{pi}=0.18$ IN ACCORDANCE WITH ASCE 7, 2010 EDITION, CHAPTER 28 (WIND LOADS ON BUILDING - MWFRS (ENVELOPE PROCEDURE)). A MINIMUM ROOF ASSEMBLY DEAD LOAD OF 10 PSF IS CONSIDERED IN THE TABULATED VALUES (UPLIFT PRESSURE REDUCE BY 0.6 TIMES 10 PSF).

GENERAL NOTES:

- CHART VALUES ARE IN INCHES.
- IN HIGH WIND SPEED AREAS, PLEASE REFER TO R-CONTROL SIP TECHNICAL BULLETINS FOR SPACING REQUIREMENTS.

Roof/Floor - Diaphragm Loads - PLF					
LOAD DESIGN CHART #7					
CONNECTION DETAILS					
SIP 139, SIP-139a, SIP-140 and SIP-141					
FASTENER SPACING				ALLOWABLE STRENGTH (PLF)	
BOUNDARIES ¹		SPLINES ²	SIPS TO SUPPORT PARALLEL TO SHEAR		
R-CONTROL SCREWS ³	8D BOX NAILS	8D BOX NAILS	R-CONTROL SCREWS ³	500	
6"	3" @ top and bottom	3", two rows each side of joint and staggered	12"		750
4"	3" @ top and bottom	3", two rows each side of joint and staggered	12"		
3"	3" @ top and bottom	3", in two rows each side of joint and staggered	12"	850	

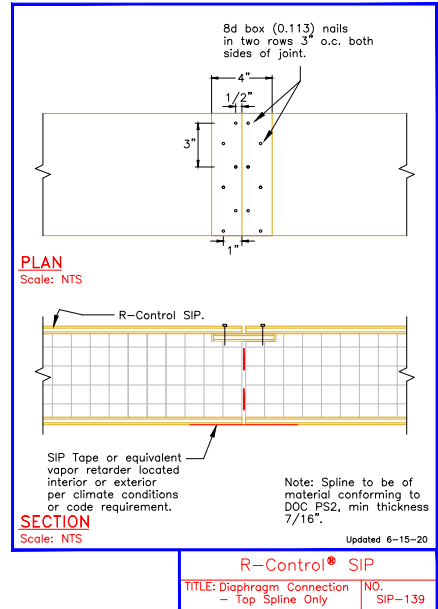

¹ DIAPHRAGM BOUNDARY ELEMENTS MUST CONSIST OF FULL-DEPTH, SOLID-SAWN LUMBER, 2-INCH MINIMUM NOMINAL WIDTH, MINIMUM SPECIFIC GRAVITY OF 0.50, INSERTED IN SIP CORE, CONTINUOUS ACROSS PANEL JOINTS. PANEL EDGES PARALLEL TO APPLIED SHEAR SHALL BE REINFORCED WITH SOLID-SAWN LUMBER, 4-INCH MINIMUM NOMINAL WIDTH, AND MINIMUM SPECIFIC GRAVITY OF 0.50.

² NAILS CONNECT SIP FACINGS AT JOINTS TO OSB SURFACE SPLINES LOCATED UNDER TOP FACE AT ALL PANEL EDGES, AT THE TABULATED SPACING.

³ DIAPHRAGM SECURED TO SUPPORT MEMBERS WITH R-CONTROL SCREWS AT THE TABULATED SPACING AND A MINIMUM 1-5/8 INCH PENETRATION INTO THE RECEIVING MEMBER.

GENERAL NOTES:

- CHART VALUES ARE POUNDS PER LINEAL FOOT.
- SURFACE, BLOCK, OR LUMBER BLOCK SPLINE.
- LOADS LIMITED BY ULTIMATE FAILURE LOAD DIVIDED BY A FACTOR OF SAFETY OF THREE.

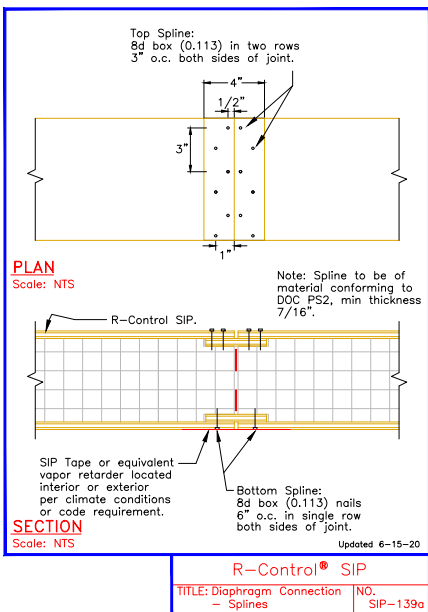

R-Control® SIP
TITLE: Diaphragm Connection - Splines NO. SIP-139a

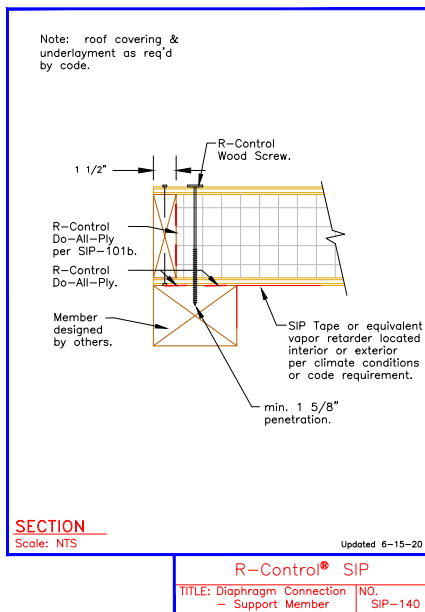

R-Control® SIP
TITLE: Diaphragm Connection - Support Member NO. SIP-140

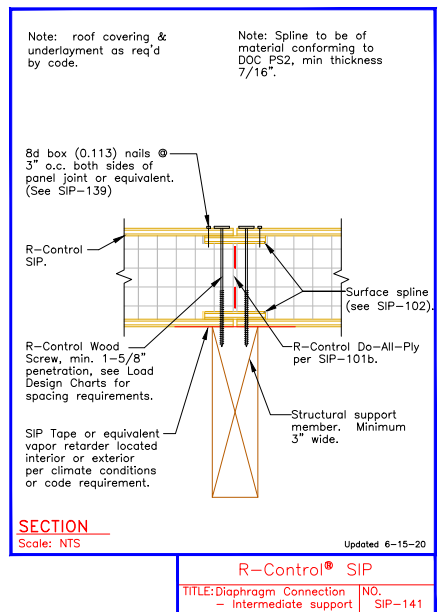

R-Control® SIP
TITLE: Diaphragm Connection - Intermediate support NO. SIP-141

Ready to take control? Start here.

If you're wondering how R-Control SIPs can work on your next project, just contact your nearest R-Control supplier. They'll be happy to collaborate on design, walk you through R-Control SIP installation, provide test data, pricing, and answers to all your questions. Start by visiting our web site: www.r-control.com.



R-Control SIPs are made exclusively with Foam-Control EPS. R-Control SIPs and Foam-Control EPS are manufactured by AFM Corporation licensees.

Copyright © 2020 AFM Corporation. All rights reserved. Printed in USA. R-Control, Foam-Control, Perform Guard, and Control, Not Compromise are registered trademarks of AFM Corporation, Lakeville, MN.

RC02-06/20



**CONTROL,
NOT COMPROMISE.®**